



YOUR BEST
SOLAR SUPPLIER



 @Anernsolar

 www.Anernstore.com

 group@anern.com

ADDRESS. GUANGZHOU

5th Floor, Building B, No.2817 Kaichuang Avenue, Science Zone, Huangpu District, Guangzhou
Tel: +8620 89269669/89269660

ADDRESS. SHENZHEN

Room 720, Hongfa Center Building, No.1004, Xihu Road, Bao'an District, Shenzhen
Tel: +86775 27802026/27802025



SOLAR POWER SYSTEM

[www. Anerngroup.com](http://www.Anerngroup.com)



PREFACE

With electricity rates rising as much as 40% over the past decade, many people are now realizing the benefits of going solar: clean, renewable energy, at a fraction of the price that utility companies charge to use power from the grid.

If you're considering the many benefits of solar, it's important to understand the types of solar systems that are currently available, so you can choose the one best suited for you. The three types of solar power systems are grid tied, off grid, and hybrid. Each system offers a unique power generation and power storage experience.



INTRODUCTION

- 1 PART ONE
REMARKS FOR THREE DIFFERENT TYPES OF SYSTEMS
- 2 PART TWO
GRID-TIE SOLAR POWER SYSTEMS
- 3 PART THREE
OFF-GRID SOLAR POWER SYSTEMS
- 4 PART FOUR
HYBRID SOLAR POWER SYSTEMS
- 5 PART FIVE
CORE COMPONENTS INTRODUCTION
- 6 PART SIX
CASE PRESENTATION



▶▶▶ REMARKS FOR 3 DIFFERENT TYPES OF SOLAR POWER SYSTEMS



There are three basic types of solar power systems: Off-Grid Solar System, Grid-tied Solar System, and Hybrid Solar System. Here's a quick summary of the differences between them:

Grid-tied Solar System is designed to send solar power directly to local loads at daytime, and extra solar power can be sent to grid for selling.

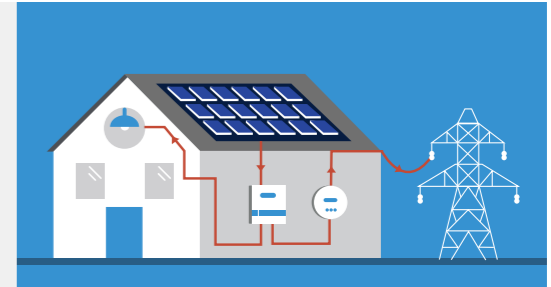

Off-grid Solar System is designed to bring solar power to remote locations where there is no grid access. It requires a battery bank to store the energy which your solar panels generate. They are often connected with a diesel generator in parallel to provide backup during long time without sunlight.

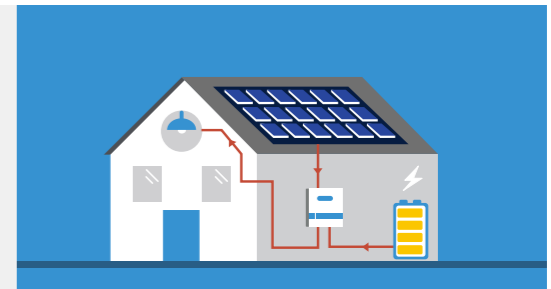

Hybrid Solar System needs to connect to the grid, but also includes batteries. It's also called "hybrid system" or "solar energy storage system", aims at providing backup power in case of the grid power outage.

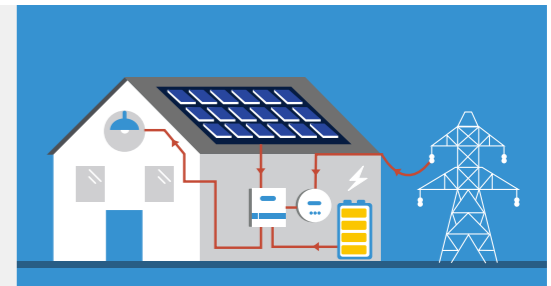

Each type of system are specially configured with optimization and requires unique equipment that is compatible with the specific application, so your understanding of which exact system you need is the first step to buy the solar systems.

▶▶▶ GRID-TIE SOLAR POWER SYSTEMS

Grid-tied Solar System is, by far, the most cost-effective way to go solar. Because batteries are the most expensive component of any solar system, but grid-tied solar systems can skip them completely!



SO HOW DO GRID-TIED SOLAR POWER SYSTEMS WORK?

Grid-tied solar systems send the solar energy into the grid, where it is stored for later use. Under a net metering agreement, the system owner receives credit for anything they generate, and they can make use of that energy at any time.

It's kind of like a bank account: sending energy into the grid is like making a deposit, and using electricity is like withdrawing against your account balance. If you overdraft i.e. use more energy than you produce in a given month, the utility bills you for the difference.

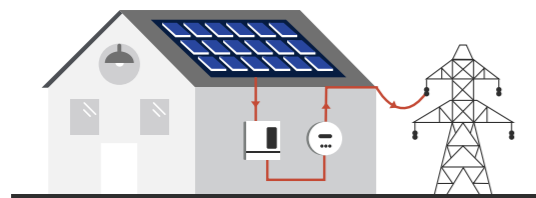

Send the solar energy into the grid

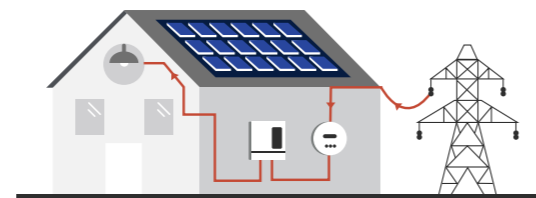

Use the solar energy from the grid

ON GRID SOLAR SYSTEM WIRING DIAGRAM

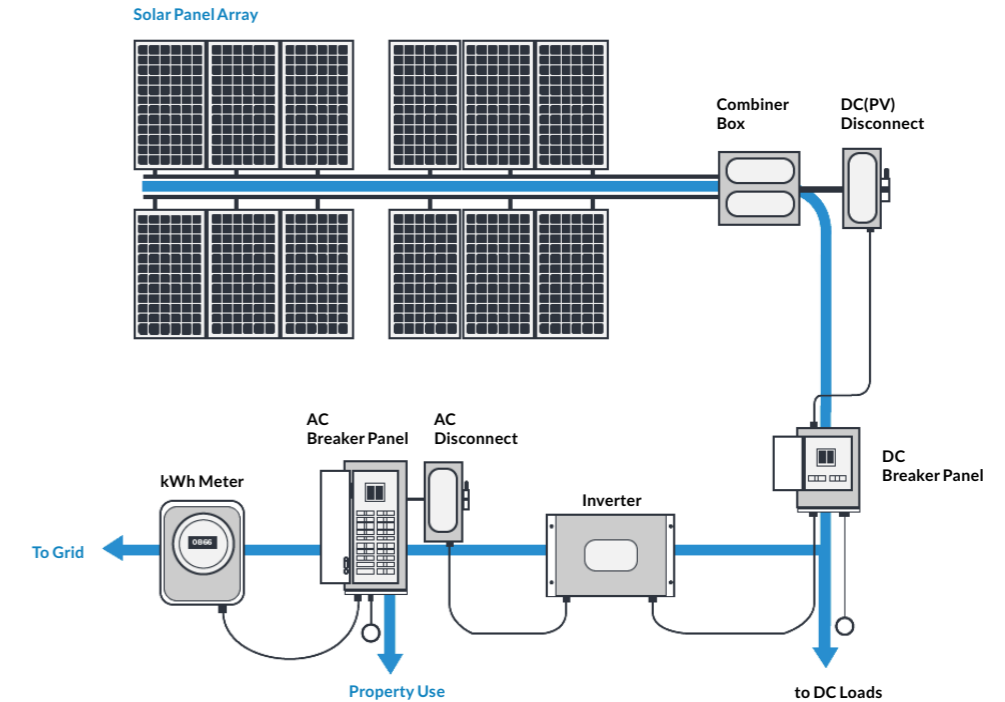

ANERN ON-GRID SOLAR POWER SYSTEM OVERVIEW

SOLAR PANEL	Half Cell 500/550/600W
INVERTER	On-grid Inverter 3KW-136KW
SOLAR PANEL BRACKET	Ground or Roof
OTHER ACCESSORIES	Circuit Breaker / Cable / Meter / Wifi Module

▶▶▶ OFF-GRID SOLAR POWER SYSTEMS



Off-grid solar system is best for delivering power to remote locations where there is no access to a utility line.

Who live off the grid are solely responsible for generating their own electricity. This is usually accomplished by building an off-grid solar system that can cover a day's worth of electricity usage, with a backup generator to supplement production during long stretches of bad weather.

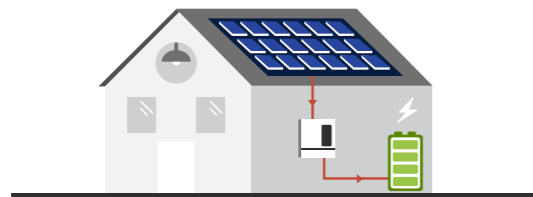

Send the solar energy into the battery

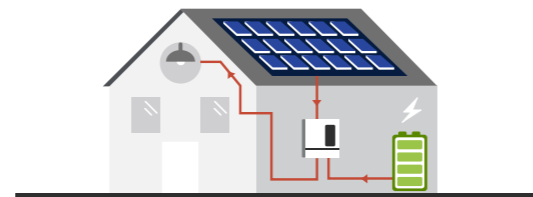

Use the solar energy from the battery

OFF GRID SOLAR SYSTEM WIRING DIAGRAM

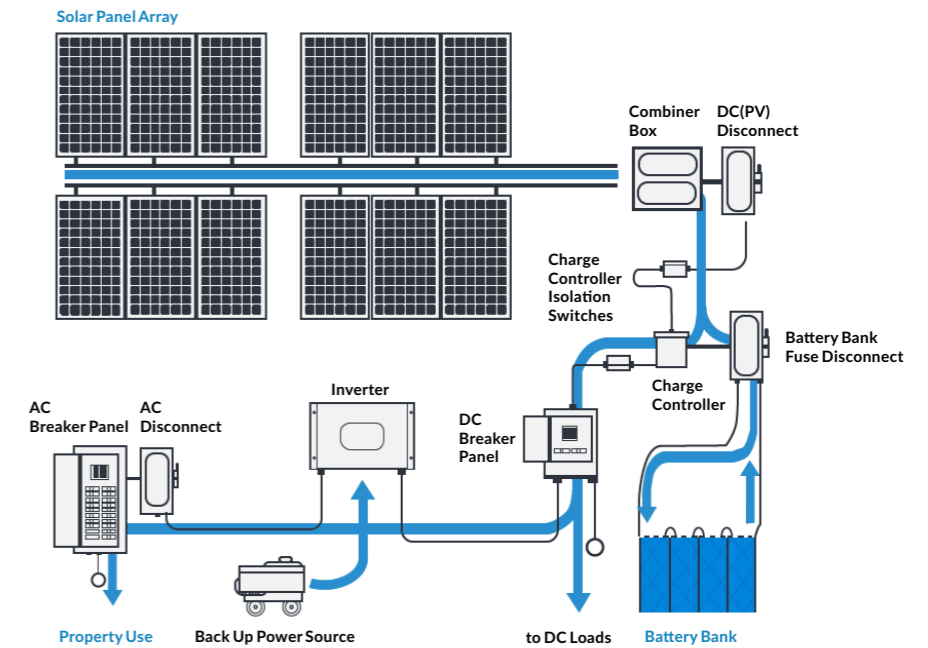

ANERN OFF-GRID HOME SOLAR POWER SYSTEM

SOLAR PANEL	Half Cell 450W
INVERTER	Off-grid Inverter 3.6/6.2/10.2KW
SOLAR PANEL BRACKET	Ground or Roof
BATTERY	Lithium Battery or Gel Battery
OTHER ACCESSORIES	Circuit Breaker / Cable / Wifi Module

ANERN OFF-GRID COMMERCIAL SOLAR POWER SYSTEM

SOLAR PANEL	Half Cell 550W
CONTROLLER	MPPT Controller 96/192/384V, 80-100A
INVERTER	Off-grid Inverter 15/20/30/50/100KW(Three Phase)
SOLAR PANEL BRACKET	Ground or Roof
BATTERY	Lithium Battery or Gel Battery
OTHER ACCESSORIES	Circuit Breaker / Cable / Wifi Module

HYBRID SOLAR POWER SYSTEMS



If you live on the grid, but you want protection from power outages, your best bet is a battery backup system.

Hybrid solar systems connect to the grid, and function like a normal grid-tie system on a day-to-day basis. However, they also feature a backup battery bank that takes over in case of outages.

When grid power goes out, your inverter automatically disconnects from the grid and draws on energy stored in your battery bank, which will keep your appliances running when the grid goes down.

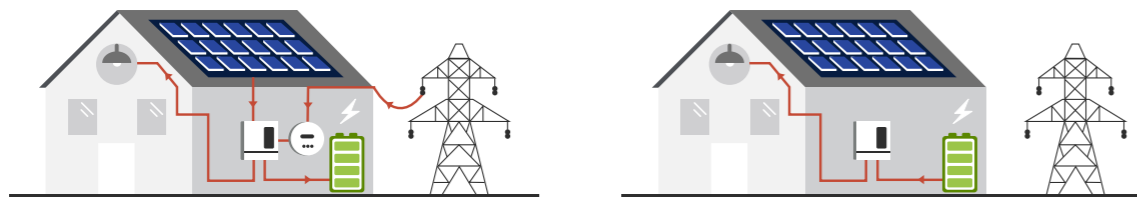

When connected to the grid

When grid power goes out

HYBRID SOLAR SYSTEM WIRING DIAGRAM

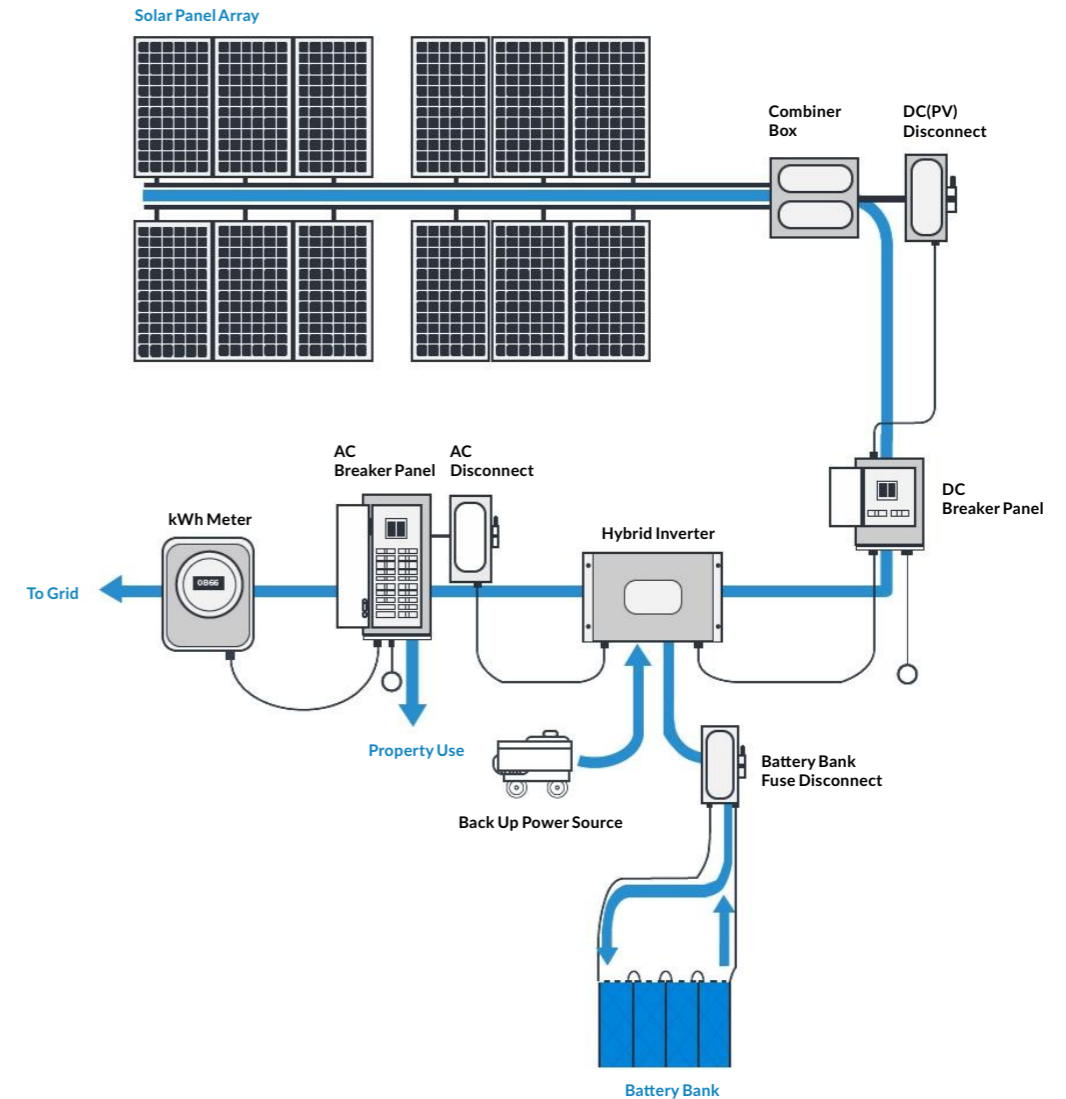

ANERN HYBRID SOLAR POWER SYSTEM OVERVIEW

We provided four different solar power solutions according to the grid conditions in the market, and customers can choose according to the actual situation.

MAIN STABILITY CONFIGURATION

SOLAR PANEL	Half Cell 550W
PV COMBINER	4/6/8/10 Strings
INVERTER	Hybrid Inverter 20/30/50/60/75/100/150/200/300/400/500/1000KW
SOLAR PANEL BRACKET	Ground or Roof
OTHER ACCESSORIES	Circuit Breaker / Cable / WIFI Module

MAIN UNSTABLE WITH DIESEL ENGINE CONFIGURATION

SOLAR PANEL	Half Cell 550W
PV COMBINER	4/6/8/10 Strings
CONTROLLER	MPPT Controller 96/192/384V, 80-100A
INVERTER	Hybrid Inverter 20/30/50/60/75/100/150/200/300/400/500/1000KW
BATTERY	Lead-acid Battery 12V
SOLAR PANEL BRACKET	Ground or Roof
OTHER ACCESSORIES	Circuit Breaker / Cable / WIFI Module

MAIN UNSTABLE WITHOUT DIESEL ENGINE CONFIGURATION

SOLAR PANEL	Half Cell 550W
PV COMBINER	4/6/8/10 Strings
CONTROLLER	MPPT Controller 96/192/384V, 80-100A
INVERTER	Hybrid Inverter 20/30/50/60/75/100/150/200/300/400/500/1000KW
BATTERY	Lead-acid Battery 12/2V
SOLAR PANEL BRACKET	Ground or Roof
OTHER ACCESSORIES	Circuit Breaker / Cable / WIFI Module

PEAK LOAD SHIFTING CONFIGURATION

SOLAR PANEL	Half Cell 550W
PV COMBINER	4/6/8/10 Strings
CONTROLLER	MPPT Controller 96/192/384V, 80-100A
INVERTER	Hybrid Inverter 20/30/50/100/150/200/300/500/1000KW
BATTERY	Lead-acid Battery 12/2V
SOLAR PANEL BRACKET	Ground or Roof
OTHER ACCESSORIES	Circuit Breaker / Cable / WIFI Module

*Mainly aimed at the case with big difference between daytime and evening electricity price. At daytime solar power and battery power are supplied to the loads, and at night charge the battery by grid power when the grid electricity price get lower.

►►► CORE COMPONENTS INTRODUCTION

ULTRA-HIGH POWER SOLAR MODULES

400W / 450W / 550W / 600W

Based on Anern Solar's leading multi-busbars technology, modules incorporate 182mm silicon wafers, non-destructive cutting and high-density interconnect technologies, allowing over 600W power output and up to 21.5% module efficiency.



Features

- Multiple Busbars (MBB)**
 Densely distributed grid lines, uniform load, multi-busbars design. Output power increased by more than 5W.
- Lossless Cut**
 Lossless cutting technology, smooth cutting surface without burrs. Low cell cracking risks, micro-cracking is reduced by more than 50%.
- Half-cut**
 Current density is reduced by 1/2, Internal power loss reduced to 1/4 of conventional modules. Rated output power increased by 5~10W.
- New Welding Wire**
 Adopt round wire solder ribbon, low shading area. Multiple reflections of incident light, power increased by 1-2W.
- Shading, Not Compromising Energy**
 Up-down symmetrical parallel module design. Effectively reduce current mismatch due to shading.
- High-Density Encapsulation Technology**
 Adopts advanced high-density encapsulation technology to ensure the perfect balance of efficiency and reliability. Module efficiency increased by more than 0.15%.

Production Workshop Display

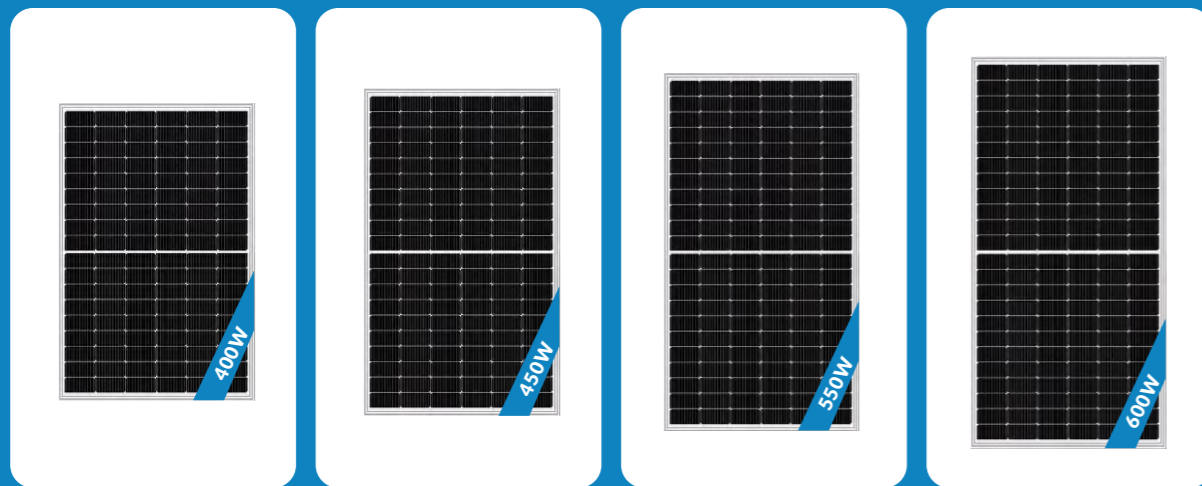

ON-GRID INVERTER

Our on-grid inverters have high conversion efficiency, safe and stable performance. They can meet different application environment requirements such as indoor and outdoor. They are widely used in small and medium-sized photovoltaic power generation systems such as residential buildings, commercial roofs and farms.



Features

Efficient

- Support over capacity ratio: 1.6X DC input overload.
- High energy continuous output: 1.1X AC output overload.
- The MPPT efficiency is up to 99.90%.
- The lowest starting voltage can reach to 160V.

Flexible

- Intelligent IV scanning function: it can accurately locate the fault string and make the operation and maintenance more efficient.
- 4 MPPT : more flexible string configuration and more choices for installation.
- Remote maintenance: support online remote upgrade.
- Fan drawer design: 1 minute quick fan replacement.

Reliable

- IP66.
- Input reverse wiring protection, AC short circuit protection, AC over current protection, input over voltage protection, Isolation protection, PV string detection, Anti-islanding protection, over temperature protection, grounding fault monitoring, ZVRT, Anti-PID function, etc.

Intelligent

- Intelligent monitoring: one-stop intelligent operation and maintenance platform for users, providing comprehensive and intuitive power station data monitoring.
- Support RS485 / USB / WiFi / GPRS.



Home On-grid Inverter



Commercial On-grid Inverter

Production Workshop Display

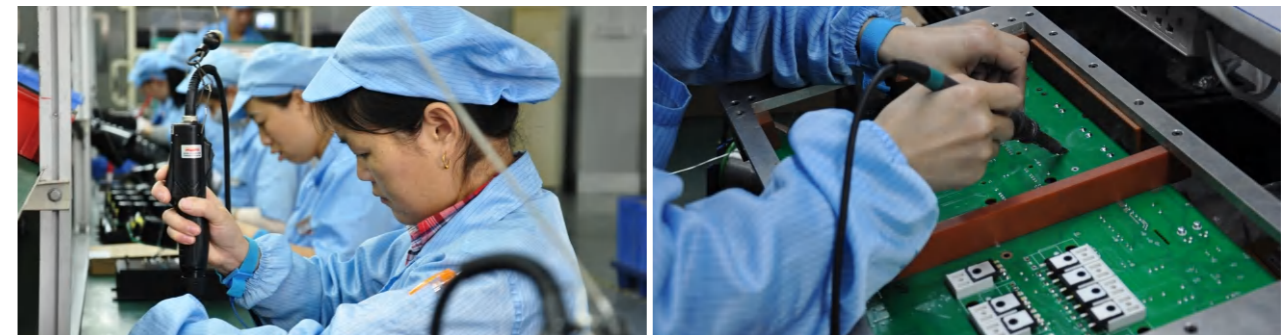

OFF-GRID INVERTER

An inverter converts DC power from your solar panels into AC power, the format used by most household appliances. Your inverter size is based on your peak power requirements, the amount of electrical loads you want to run at the same time. If you need to run several power-hungry appliances simultaneously, you'll need a larger inverter to cover your peak power demand.



Features

- The drive protection is Mitsubishi inner works, and the perfect drive protection circuit ensures the reliable operation of IGBT.
- Fast Dynamic Response (patented Technology): Double closed-loop feedback circuit, internal loop current environmental protection certificate non-distorted non-linear load waveform; external loop voltage environmental protection certificate sudden load voltage drop $\leq 1\%$, reaction speed ≤ 2 ms.
- Reasonable combination of components, inversion efficiency $\geq 90\%$.
- Output frequency 50/60Hz switching to meet different device power requirements, other frequencies can be customized.
- Built-in isolation transformer with pure sine wave output and resistance, induction, capacitance and mixed load.
- Friendly interactive interface, touch-display integration. Display DC input voltage, AC output voltage, frequency, power, temperature, status indication and fault indication.
- Digital technology design, high adjustability, DC high/low voltage, DC low voltage recovery, output high/low voltage, output overload can be set within a certain range.
- Full And Efficient Protection Function, to protect against damage under any load, with input connection back protection, input high/low voltage protection, output low/voltage protection, IGBT drive protection, output over load protection, current limit protection, overheat protection, three-phase unbalance protection.
- The generator start by dry contact, can start the generator in advance before the power supply is low voltage, and the start voltage can be set.
- Communication: RS485, USB, WIFI, GPRS, CAN. Data can be accessed to the Internet of Things, monitored remotely, and queried for historical data.
- Communication protocol: Modbus RTU



Home Off-grid Solar Inverter



Commercial Off-grid Solar Inverter

Production Workshop Display



HYBRID INVERTER

The hybrid inverter can control the charging and discharging process of batteries to transform AC and DC, and can directly supply power to AC loads without grid. Hybrid inverter consists of DC/AC bi-directional converters and control units, etc. Controller receives background control instruction through communication, and controls the converter to charge or discharge the battery according to the symbol and size of power instruction, so as to adjust the active and reactive power of the grid. The PCS controller communicates with the BMS through the CAN interface to obtain the battery group status information, which can realize the protective charge and discharge of the battery to ensure the safe operation of the battery.



Features

- Specially designed for smart grid and smart micro-grid, accepting grid dispatching, peak cutting and valley filling;
- It has a wide application range, can connect with different energy storage batteries such as lead-acid battery, lithium battery, super capacitor and vanadium battery, etc.
- Bidirectional inverter, a variety of battery charging and discharging modes optional;
- It has the function of setting working mode in time period, can set reasonable working mode according to the characteristics of local power grid;
- Integrated EMS management system, in the solar energy storage system, can set the priority of solar, battery and grid (optional);
- It has two operation modes: grid-connected (charge-discharge) operation and independent isolated network operation. It can control active power and reactive power output according to the instructions of the grid dispatching department and has four-quadrant full capacity operation;
- RS485, CAN bus and other communication interface are optional, standard MODBUS_RTU communication protocol, remote monitoring.



Home Hybrid Solar Inverter



Commercial Hybrid Solar Inverter

Production Workshop Display



BATTERY BANK

Batteries store the energy you produce during the day, so you can draw power from your battery bank to run appliances when the sun isn't shining. Our off-grid solar power system uses deep-cycle batteries, deep-cycle Lithium Iron Phosphate Technology (LifePO4) batteries which are designed to be discharged and recharged gradually. These are sized to cover your energy usage for one night, then recharge from solar during the day, completing one charge and discharge cycle over a 24-hour period.



Features

- It adopts lithium iron phosphate battery, which is environmentally friendly and safe.
- The service life is long, the product can be guaranteed for 5 years, and the service life is more than 8 years.
- Modular design, easy for customers to install and maintain.
- Small size, light weight, the same energy lithium battery, the weight and volume are 1/3 of the lead acid.
- The configuration is flexible, and different capacities can be configured according to customer needs.
- Built-In Safety – BMS with Breaker On/Off Switch for Shipping & Installation.

Production Workshop Display



Home Solar Lithium Battery



Commercial Solar Lithium Battery

RACKING

Our off-grid solar kits come with Aluminum roof mount or ground mount racking materials. Aluminum racking materials are tested and proven to perform in extreme environments. Products are fully certified, code compliant and backed by a limited 20-year warranty.



Roof Mount



Ground Mount Racking



REMOTE MONITORING SYSTEM

Our remote monitoring platform is a new generation of photovoltaic networking monitoring platform. It includes power monitoring, power management, fault processing equipment, power generation capacity and investment income data analysis functions, provides professional power management and intelligent operation and maintenance scheme for distributors and end users.

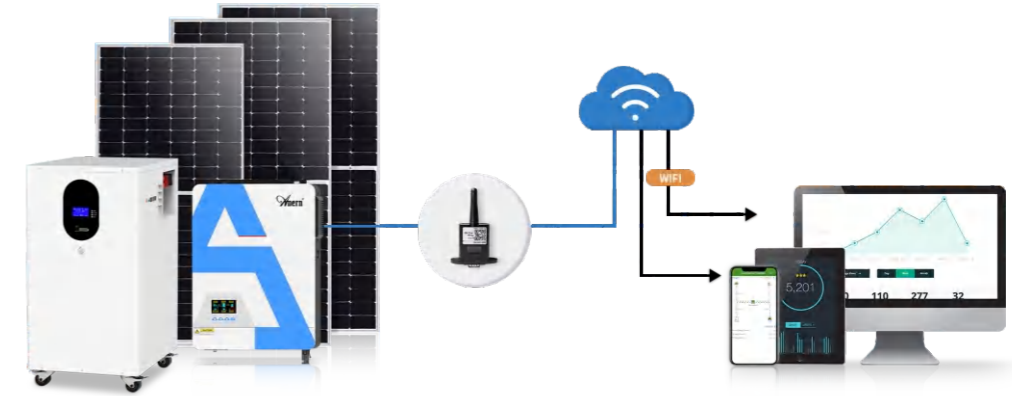

▶▶▶ CASE PRESENTATION



In Africa 1MW



In Lebanon 80KW



In Afghanistan 100KW



In Philippines 300KW



In Cambodia 50KW



In Burma 11KW



In Italy 5.5KW*25 sets



In Turkey 7.5KW



In Yemen 25KW



In Indonesia 10KW



In Slovakia 5.5KW



In Uzbekistan 5KW*100 sets



In Peru 180KW



In Nigeria 80KW



In Germany 35KW



In Malaysia 200KW



In Zimbabwe 250KW



In France 8.5KW